

CRJ AURA 2018

SH Cadet - PouleA	DESCHAMP	PHENGPHACHANH	CORRIETTE	Vict.	Sets diff.	Pts diff.	Clt
1-DESCHAMP Grégoire-N2 (BACOL)	FFBaD						
PHENGPHACHANH Maxime-R5 (C)		FFBaD	24				
CORRIETTE Maxence-R5 (BACLY6)			24	FFBaD			

SH Cadet - PouleB	LACROIX	DUMONT-GIRARD	BARRIERE	Vict.	Sets diff.	Pts diff.	Clt
2-LACROIX Quentin-R4 (BACLY69)	FFBaD						
DUMONT-GIRARD Nicolas-R5 (CD)		FFBaD	25				
BARRIERE Geraud-R5 (CD 63-63)			25	FFBaD			

CRJ AURA 2018

SH Cadet - PouleC	BARTHUEL		BERTHOMME		PLOTTON		Vict.	Sets diff.	Pts diff.	Clt
BARTHUEL Adrien-R5 (CD 63-63)	FFBaD									
BERTHOMME Romain-R5 (CBC69-)			FFBaD		26					
PLOTTON Noa-R5 (CBR42-42)			26		FFBaD					

SH Cadet - PouleD	BULIDON		CAILLE		LOVANG		Vict.	Sets diff.	Pts diff.	Clt
BULIDON Maxence-R5 (CD 63-63)	FFBaD									
CAILLE Guillaume-R5 (ABC74-74)			FFBaD		27					
LOVANG Kimi-R5 (BACO69-69)			27		FFBaD					

CRJ AURA 2018

SD Cadet - PouleA

	MAKINADJIAN	MANARANCHE	BESNIER	Vict.	Sets diff.	Pts diff.	Clt
1-MAKINADJIAN Lisa-N3 (CD 26/0)	FFBaD						
MANARANCHE Julie-R4 (CD 38-38)		FFBaD	28				
BESNIER Anouk-R6 (ABC74-74)		28	FFBaD				

SD Cadet - PouleB

	HOAREAU	MAMMERI	PRIMET	Vict.	Sets diff.	Pts diff.	Clt
2-HOAREAU Li-Lou-N3 (CD 38-38)	FFBaD						
MAMMERI Tanina-R4 (BACO69-69)		FFBaD	29				
PRIMET Orlane-R5 (MBC42-42)		29	FFBaD				

CRJ AURA 2018

SD Cadet - PouleC	BASTIDE		SOCQUET-CLERC		JANIN		Vict.	Sets diff.	Pts diff.	Clt
BASTIDE Juliette-N3 (CD 63-63)	FFBaD									
SOCQUET-CLERC Mathilde-N3 (PN)			FFBaD		30					
JANIN Emma-R5 (ACB38-38)			30		FFBaD					

SD Cadet - PouleD	POULBOT		ROCHE		BRON		Vict.	Sets diff.	Pts diff.	Clt
POULBOT Noémie-N3 (CD 63-63)	FFBaD									
ROCHE Jade-R5 (BB42-42)			FFBaD		31					
BRON Salomé-R5 (TBC74-74)			31		FFBaD					

CRJ AURA 2018

double hommes
série Cadet

1-BULIDON Maxence-N3 (CD 63-63)
PHENGPACHANH Maxime-R4 (CD 38-38)

167

VIVIANT Clarence-R5 (ABC74-74)
BARTHUEL Adrien-R5 (CD 63-63)

313

CAILLE Guillaume-R5 (ABC74-74)
CRETAUD Thomas-R4 (ABC74-74)

168

BERTHOMME Romain-R4 (CBC69-69)
LACROIX Quentin-R4 (BACLY69-69)

329

DUMONT-GIRARD Nicolas-R5 (CD 38-38)
GEREAU Maxence-R5 (BCIA38-38)

169

REMAUD Julien-R5 (CD 26/07-26/07)
FRESSE Guillaume-R5 (CD 26/07-26/07)

314

VOINIER Hugo-R4 (SCPGBAD42-42)
CORRIETTE Maxence-R5 (BACLY69-69)

170

2-MAS Korneel-R5 (CBC69-69)
LOVANG Kimi-N3 (BACO69-69)

CRJ AURA 2018

double dames série Cadet

1-MAMMERI Tanina-N2 (BACO69-69)
MANARANCHE Julie-N2 (CD 38-38)

CAFFIERS Julie-R6 (CD 26/07-26/07)
POULBOT Noémie-N3 (CD 63-63)

HOAREAU Li-Lou-N3 (CD 38-38)
SOCQUET-CLERC Mathilde-N3 (PMBB74-74)

DEPOORTER Charlène-R4 (CBC69-69)
BRON Salomé-R4 (TBC74-74)

JANIN Emma-N3 (ACB38-38)
PRIMET Orlane-N3 (MBC42-42)

2-MAKINADJIAN Lisa-N2 (CD 26/07-26/07)
BASTIDE Juliette-N2 (CD 63-63)

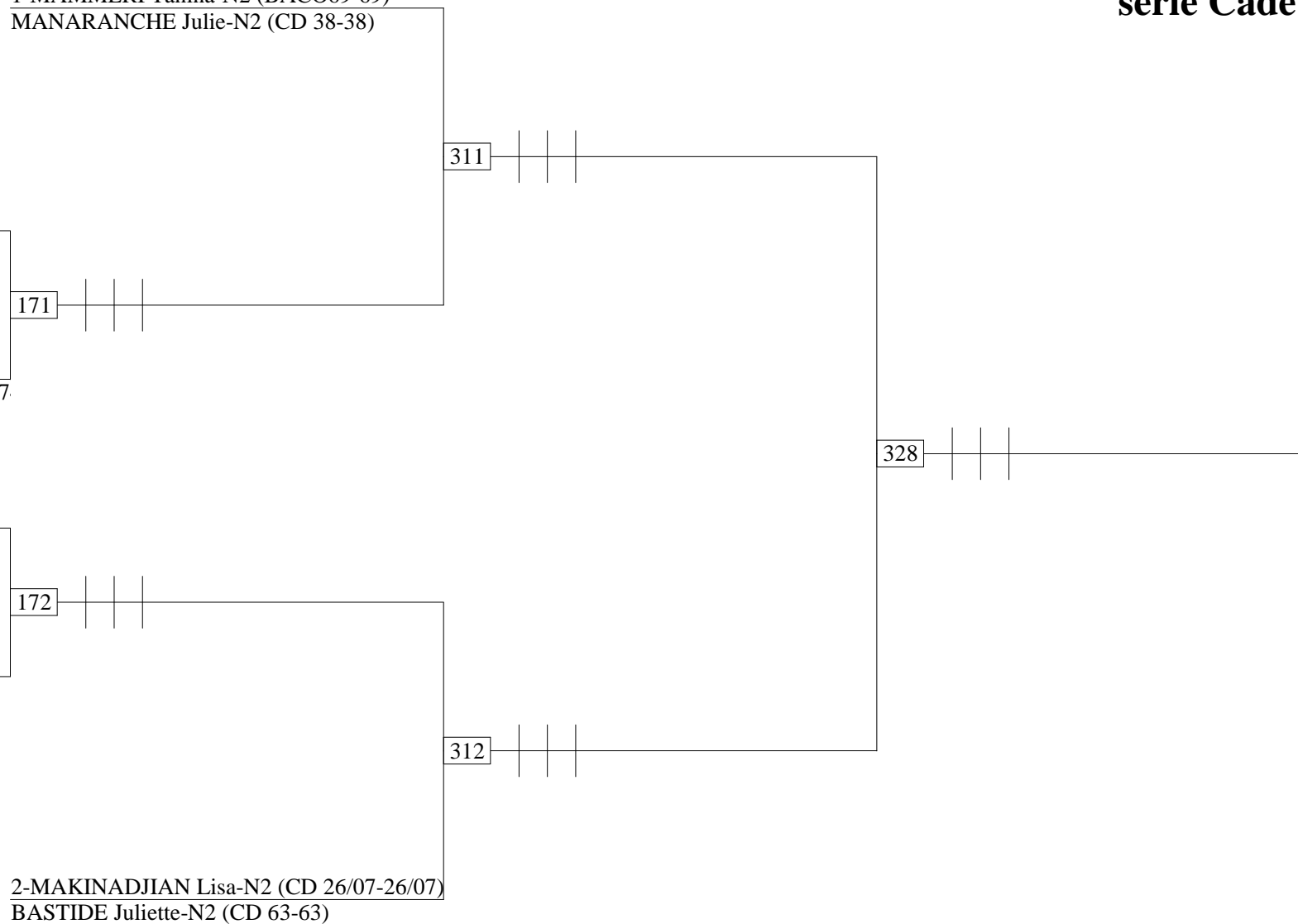

CRJ AURA 2018

Mx Cadet - PouleA	DESCHAMP	LACROIX		GEREAU		Vict.	Sets diff.	Pts diff.	Clt
	MAMMERI	SOCQUET-CLERC		HOAREAU					
1-DESCHAMP Grégoire-R4 (BAC069-69)	FFBaD								
MAMMERI Tanina-R4 (BAC069-69)									
LACROIX Quentin-R5 (BACLY69-69)									
SOCQUET-CLERC Mathilde-R4 (PN)		FFBaD		105					
GEREAU Maxence-R6 (BCIA38-38)									
HOAREAU Li-Lou-R5 (CD 38-38)				105	FFBaD				

Mx Cadet - PouleB	LOVANG	CRETAUD		BERGER		Vict.	Sets diff.	Pts diff.	Clt
	POULBOT	BRON		GUERRIN					
2-LOVANG Kimi-R5 (BAC069-69)	FFBaD								
POULBOT Noémie-R4 (CD 63-63)									
CRETAUD Thomas-R4 (ABC74-74)									
BRON Salomé-R5 (TBC74-74)		FFBaD		106					
BERGER Théo-D7 (MVBC38-38)									
GUERRIN Emilie-D7 (BCC69-69)				106	FFBaD				

CRJ AURA 2018

Mx Cadet - PouleC

	PHENGPHACHAN JANIN	BERTHOMME DEPOORTER	CAILLE BESNIER	Vict.	Sets diff.	Pts diff.	Clt
PHENGPHACHANH Maxime-R4 (C JANIN Emma-R4 (ACB38-38)	FFBaD						
BERTHOMME Romain-R6 (CBC69- DEPOORTER Charlène-R4 (CBC69-		FFBaD	107				
CAILLE Guillaume-D7 (ABC74-74) BESNIER Anouk-R6 (ABC74-74)		107	FFBaD				

Mx Cadet - PouleD

	BULIDON BASTIDE	DESSUS MAKINADJIAN	VOINIER PRIMET	Vict.	Sets diff.	Pts diff.	Clt
BULIDON Maxence-R4 (CD 63-63) BASTIDE Juliette-R4 (CD 63-63)	FFBaD						
DESSUS Aurelien-R6 (CD 26/07-26/ MAKINADJIAN Lisa-R4 (CD 26/07-		FFBaD	108				
VOINIER Hugo-R6 (SCPGBAD42-4 PRIMET Orlane-R4 (MBC42-42)		108	FFBaD				

CRJ AURA 2018

SH Minime - PouleC			ROCHE			MICHEL			Vict.	Sets diff.	Pts diff.	Clt
	FFBaD											
ROCHE Killian-D7 (CD 63-63)			FFBaD			14						
MICHEL Quentin-D7 (CD 38-38)			14			FFBaD						

SH Minime - PouleD			GACHET			BEYROUTI			Vict.	Sets diff.	Pts diff.	Clt
GACHET Titouan-D7 (ALE38-38)	FFBaD											
			FFBaD									
BEYROUTI Wilfrid-D7 (BACO69-69)						FFBaD						

CRJ AURA 2018

SH Minime - PouleA

		LIGER	BONNAMOUR	Vict.	Sets diff.	Pts diff.	Cl
	FFBaD						
LIGER Cedric-D7 (BCM74-74)		FFBaD	12				
BONNAMOUR Arthur-D7 (CD 63-6)		12	FFBaD				

SH Minime - PouleB

		CUENOT	VIVIAN	Vict.	Sets diff.	Pts diff.	Cl
	FFBaD						
CUENOT Zacharie-D7 (GAB38-38)		FFBaD	13				
VIVIAN Sacha-D7 (ABC74-74)		13	FFBaD				

CRJ AURA 2018

SD Minime - PouleA		GUILBERT-LY	RONDAGS	Vict.	Sets diff.	Pts diff.	Clt
	FFBaD						
GUILBERT-LY Ai-Linh-R6 (CD 01-		FFBaD	8				
RONDAGS Laureline-D8 (BCM74-7		8	FFBaD				

SD Minime - PouleB	GUERRIN		LADRET	Vict.	Sets diff.	Pts diff.	Clt
2-GUERRIN Emilie-R5 (BCC69-69)	FFBaD						
		FFBaD					
LADRET Jade-R6 (MBC42-42)			FFBaD				

CRJ AURA 2018

SD Minime - PouleC		BLACHE	NEMOZ	Vict.	Sets diff.	Pts diff.	Clt
	FFBaD						
BLACHE Maeva-R6 (BACLY69-69)		FFBaD	10				
NEMOZ Louane-D7 (BCIA38-38)		10	FFBaD				

SD Minime - PouleD	HOAREAU		VEYRARD	Vict.	Sets diff.	Pts diff.	Clt
HOAREAU Malya-R6 (CD 38-38)	FFBaD						
		FFBaD					
VEYRARD Lisa-D7 (BM42-42)			FFBaD				

CRJ AURA 2018

double hommes
série Minime

1-LOUIS GAVET Rémi-R6 (CD 01-01)
LIGER Cedric-R6 (BCM74-74)

176

THIRIET Alex-D9 (GAB38-38)
CUENOT Zacharie-D9 (GAB38-38)

301

SAINTOYANT Yanis-D7 (BACO69-69)
BEYROUTI Wilfrid-D7 (BACO69-69)

177

REPITA Valentin-D8 (CD 42-42)
DIGONNET Vadim-D8 (SJBC42-42)

318

BONNAMOUR Arthur-D8 (CD 63-63)
ROCHE Killian-D8 (CD 63-63)

178

LAURENT Adrien-D7 (CD 26/07-26/07)
GACHET Titouan-D7 (ALE38-38)

302

REYNAUD Yohann-P10 (ACB38-38)
JANIN Thomas-P10 (ACB38-38)

179

2-BASTIDE Axel-R6 (BACO69-69)
BARRIONUEVO Mateo-R6 (BACO69-69)

CRJ AURA 2018

double dames série Minime

1-FARGET Maelyne-R4 (BACLY69-69)
RENAULT-SMAGGHE Vicky-R4 (CD 38-38)

GAUDREAU Clémence-D7 (BCC74-74)
POGNANTE Camille-R6 (CD 38-38)

GUERRIN Emilie-R6 (BCC69-69)
BLACHE Maeva-D8 (BACLY69-69)

LADRET Jade-R6 (MBC42-42)
HOAREAU Malya-D7 (CD 38-38)

RABEL Coline-R5 (CD 26/07-26/07)
VEYRARD Lisa-D7 (BM42-42)

NGUYEN Mai-Phuong-P10 (ACB38-38)
NEMOZ Louane-D9 (BCIA38-38)

2-LABARRE Anaé-R6 (BACLY69-69)
BERGER Sarah-R5 (CD 38-38)

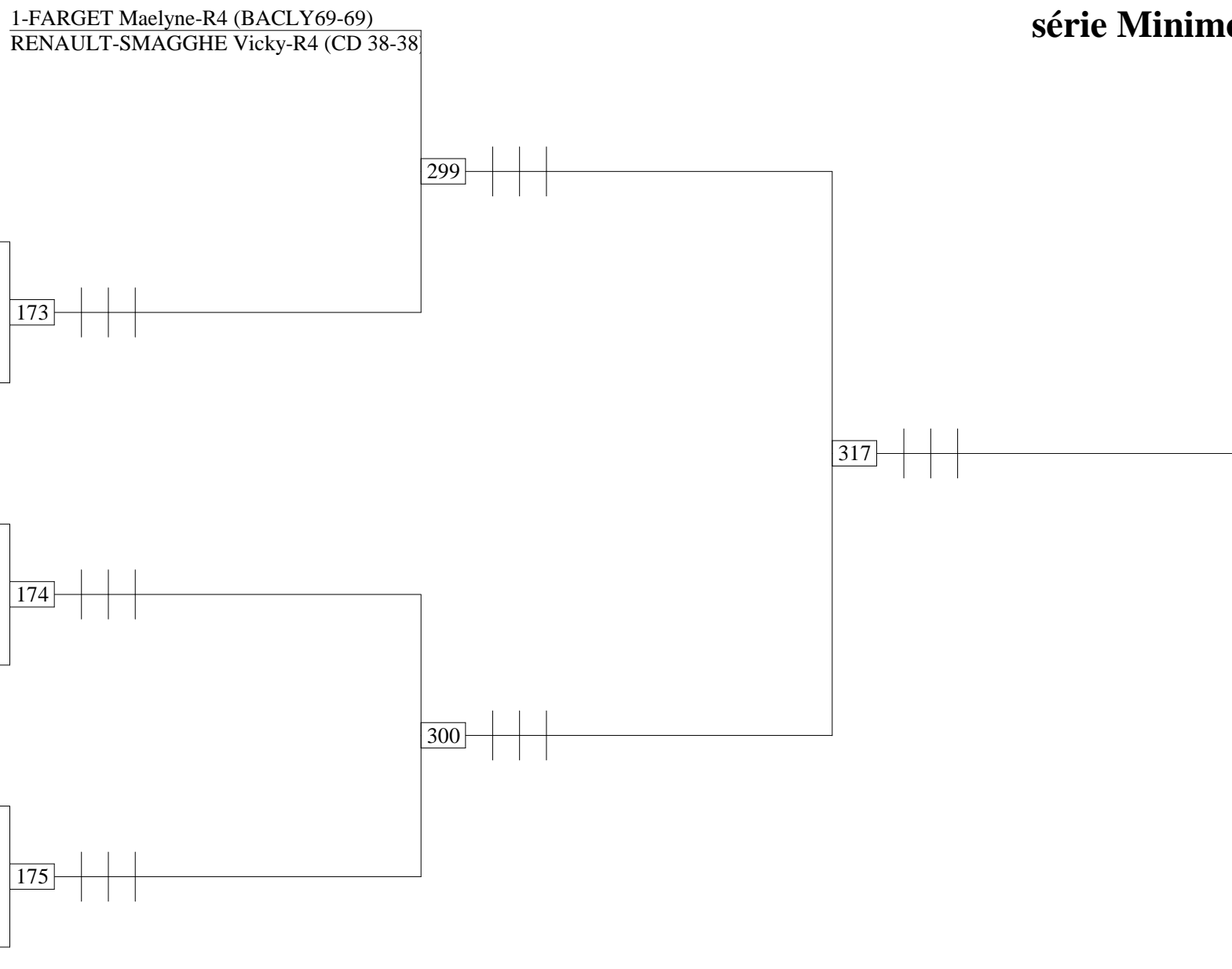

CRJ AURA 2018

Mx Minime - PouleA

		BISSAY POGNANTE			MICHEL DUVERNOIS			Vict.	Sets diff.	Pts diff.	Clt
	FFBaD										
BISSAY Ethan-D8 (BACLY69-69) POGNANTE Camille-D8 (CD 38-38)		FFBaD			96						
MICHEL Quentin-D9 (CD 38-38) DUVERNOIS Noemie-D9 (BCC73-7				96	FFBaD						

Mx Minime - PouleB

			REPITA VEYRARD			DIGONNET CORNILLON			Vict.	Sets diff.	Pts diff.	Clt
	FFBaD											
		FFBaD										
REPITA Valentin-D9 (CD 42-42) VEYRARD Lisa-D8 (BM42-42)					FFBaD							
DIGONNET Vadim-D9 (SJBC42-42) CORNILLON Eléonore-D9 (SCPGB							FFBaD					

CRJ AURA 2018

Mx Minime - Poule C

	GACHET RABEL			BOUILLON BLACHE		CUENOT NEMOZ		Vict.	Sets diff.	Pts diff.	Clt
GACHET Titouan-D8 (ALE38-38) RABEL Coline-D7 (CD 26/07-26/07)	FFBaD			99							
			FFBaD								
BOUILLON Nicolas-P10 (BACLY69) BLACHE Maeva-D8 (BACLY69-69)	99			FFBaD							
CUENOT Zacharie-D9 (GAB38-38) NEMOZ Louane-D9 (BCIA38-38)						FFBaD					

CRJ AURA 2018

double mixte
série Minime

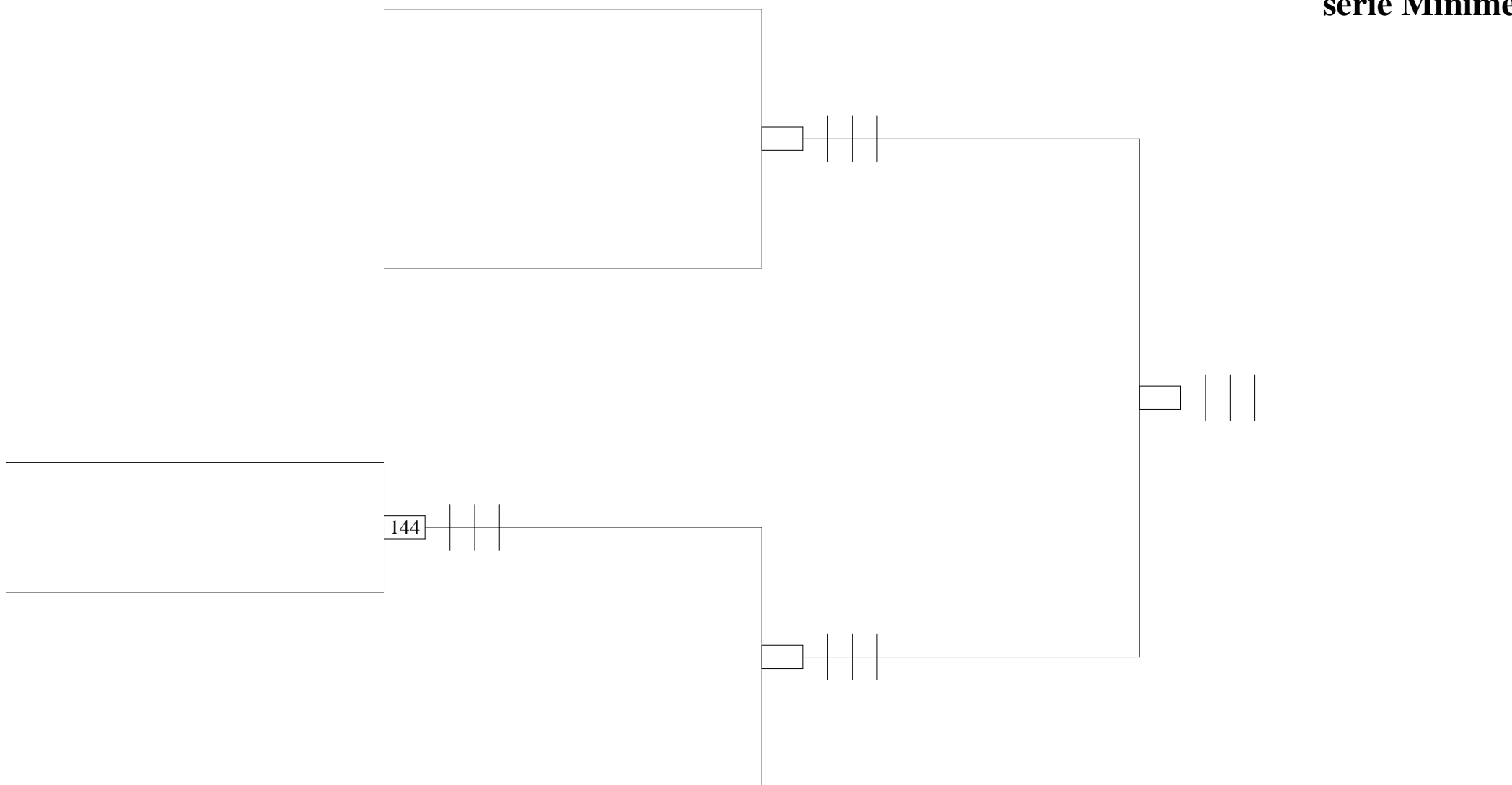

CRJ AURA 2018

SH Benjamin - Poule A

		RANNOU	GLEMBA	Vict.	Sets diff.	Pts diff.	Clt
	FFBaD						
RANNOU Hugo-D8 (BACO69-69)		FFBaD	16				
GLEMBA Pierre-D8 (CD 26/07-26/07)		16	FFBaD				

SH Benjamin - Poule B

		LUCIEN	PICHON	Vict.	Sets diff.	Pts diff.	Clt
	FFBaD						
LUCIEN Lucas-D8 (CD 01-01)		FFBaD	17				
PICHON Jules-D8 (CD 42-42)		17	FFBaD				

CRJ AURA 2018

SH Benjamin - Poule C

		FREMONT	MORIGNAT	Vict.	Sets diff.	Pts diff.	Clt
	FFBaD						
FREMONT Tom-D8 (ALE38-38)		FFBaD	18				
MORIGNAT Rémi-D8 (BACO69-69)		18	FFBaD				

SH Benjamin - Poule D

		RAMANANA-RA	FRANCON	Vict.	Sets diff.	Pts diff.	Clt
	FFBaD						
RAMANANA-RAHARY Tahina-D8		FFBaD	19				
FRANCON Anton-D8 (CBC69-69)		19	FFBaD				

CRJ AURA 2018

SD Benjamin - Poule A

		LOMBARD	CARLES	Vict.	Sets diff.	Pts diff.	Clt
	FFBaD						
LOMBARD Léna-D8 (CD 26/07-26/08)		FFBaD	20				
CARLES Oriane-D9 (CBV38-38)		20	FFBaD				

SD Benjamin - Poule B

		ANDREOLETY	DAUVERCHAIN	Vict.	Sets diff.	Pts diff.	Clt
	FFBaD						
ANDREOLETY Melissa-D8 (CD 38-38)		FFBaD	21				
DAUVERCHAIN Lucie-D9 (BOC73-73)		21	FFBaD				

CRJ AURA 2018

double hommes série Benjamin

1-CATTALANO Axel-D8 (CD 38-38)

GARDON Thibault-D8 (CD 38-38)

158

RANNOU Hugo-D9 (BACO69-69)

RIOU Théotime-D9 (BACO69-69)

305

LUCCHESI-PALLI Lucas-P10 (CD 26/07-26/07)

BALMELLE Carlo-D9 (CD 26/07-26/07)

159

LONCHAMPT Edwin-P10 (CD 63-63)

RAMANANA-RAHARY Tahina-P10 (CD 63-63)

320

SCIASCIA Noam-D9 (BPV38-38)

FRANCON Anton-D9 (CBC69-69)

160

LAURENT Tom-D9 (CD 26/07-26/07)

GLEMBA Pierre-D9 (CD 26/07-26/07)

306

FREMONT Tom-D9 (ALE38-38)

DELETTRE Malo-D9 (CD 38-38)

161

2-BISSAY Ethan-D8 (BACLY69-69)

POLODNA Aubin-Tim-D8 (PMBB74-74)

CRJ AURA 2018

SD Benjamin - Poule C

		AYMARD		CUENOT		Vict.	Sets diff.	Pts diff.	Clt
	FFBaD								
AYMARD Noémie-D8 (CD 26/07-26/08)		FFBaD		22					
CUENOT Ileya-D9 (ALE38-38)		22		FFBaD					

SD Benjamin - Poule D

		SPANO		DIGONNET		Vict.	Sets diff.	Pts diff.	Clt
	FFBaD								
SPANO Charlotte-D7 (CD 26/07-26/08)		FFBaD		23					
DIGONNET Anae-D8 (CD 42-42)		23		FFBaD					

CRJ AURA 2018

double dames série Benjamin

1-RENAULT-SMAGGHE Clarysse-D9 (CD 3-3)
BASTIDE Estel-D9 (BACO69-69)

154

LACROIX Margaux-P12 (BOC73-73)
DAUVERCHAIN Lucie-P10 (BOC73-73)

303

LENOIR Laureline-D9 (ALE38-38)
SPANO Charlotte-D9 (CD 26/07-26/07)

155

VANHULLE Charline-D9 (CD 63-63)
ANDREOLETY Melissa-D9 (CD 38-38)

319

AYMARD Noémie-P10 (CD 26/07-26/07)
LOMBARD Léna-P10 (CD 26/07-26/07)

156

RAJAUD Zoé-D9 (CD 42-42)
HOUL Nina-D9 (CD 42-42)

304

CUENOT Ileya-P10 (ALE38-38)
DUBUS Eléonore-P12 (LDCB38-38)

157

2-POULBOT Louise-D9 (CD 63-63)
RATTIN Line-D9 (CBC69-69)

CRJ AURA 2018

Mx Benjamin - Poule A

		LUCCHESI-PALLI CUENOT	BOUVIER CARLES	Vict.	Sets diff.	Pts diff.	Clt
	FFBaD						
LUCCHESI-PALLI Lucas-D9 (CD 20-21) CUENOT Ileya-P10 (ALE38-38)		FFBaD	101				
BOUVIER Celian-P10 (CBV38-38) CARLES Oriane-P11 (CBV38-38)		101	FFBaD				

Mx Benjamin - Poule B

		PICHON DIGONNET	RANNOU RAJAUD	Vict.	Sets diff.	Pts diff.	Clt
	FFBaD						
PICHON Jules-P10 (CD 42-42) DIGONNET Anaë-P10 (CD 42-42)		FFBaD	102				
RANNOU Hugo-P10 (BACO69-69) RAJAUD Zoé-D9 (CD 42-42)		102	FFBaD				

CRJ AURA 2018

Mx Benjamin - Poulet

			RAMANANA-RA VANHULLE		LAURENT AYMARD	Vict.	Sets diff.	Pts diff.	Clt
	FFBaD								
RAMANANA-RAHARY Tahina-P10 VANHULLE Charline-D9 (CD 63-63)			FFBaD		103				
LAURENT Tom-P10 (CD 26/07-26/07) AYMARD Noémie-P10 (CD 26/07-26/07)			103		FFBaD				

Mx Benjamin - Poulet

			MORIGNAT HOUL		VOIRON DAUVERCHAIN	Vict.	Sets diff.	Pts diff.	Clt
	FFBaD								
MORIGNAT Rémi-P10 (BACO69-69) HOUL Nina-D9 (CD 42-42)			FFBaD		104				
VOIRON Augustin-P10 (BOC73-73) DAUVERCHAIN Lucie-P10 (BOC73-73)			104		FFBaD				

CRJ AURA 2018

SH Poussin - PouleA			LUQUET			ROUSSEL			Vict.	Sets diff.	Pts diff.	Clt
	FFBaD											
LUQUET Adam-NC (CD 42-42)			FFBaD			4						
ROUSSEL Mathis-NC (CD 63-63)			4			FFBaD						

SH Poussin - PouleB			GARDON			JACQUEMOND			Vict.	Sets diff.	Pts diff.	Clt
2-GARDON Terence-NC (CD 38-38)	FFBaD											
			FFBaD									
JACQUEMOND Hugo-NC (CD 42-42)						FFBaD						

CRJ AURA 2018

SH Poussin - PouleC	HERTZOG		MELIN				Vict.	Sets diff.	Pts diff.	Clt
HERTZOG Baptiste-NC (SOBAD42-	FFBaD									
MELIN Kevin-NC (CD 26/07-26/07)			FFBaD							
					FFBaD					

SH Poussin - PouleD			BENEZY		ALHALLI		Vict.	Sets diff.	Pts diff.	Clt
	FFBaD									
BENEZY Enzo-NC (CD 63-63)			FFBaD		7					
ALHALLI Louniss-NC (ALE38-38)			7		FFBaD					

CRJ AURA 2018

SD Poussin - PouleA			MOREL	Vict.	Sets diff.	Pts diff.	Clt
	FFBaD						
		FFBaD					
MOREL Julie-NC (CD 26/07-26/07)			FFBaD				

SD Poussin - PouleB			TISSIER	Vict.	Sets diff.	Pts diff.	Clt
	FFBaD						
		FFBaD					
TISSIER Celia-NC (CD 26/07-26/07)			FFBaD				

CRJ AURA 2018

SD Poussin - PouleC		SELLAMI				Vict.	Sets diff.	Pts diff.	Cl
	FFBaD								
SELLAMI Nalia-NC (CD 26/07-26/0)			FFBaD						
					FFBaD				

CRJ AURA 2018

simple dames
série Poussin

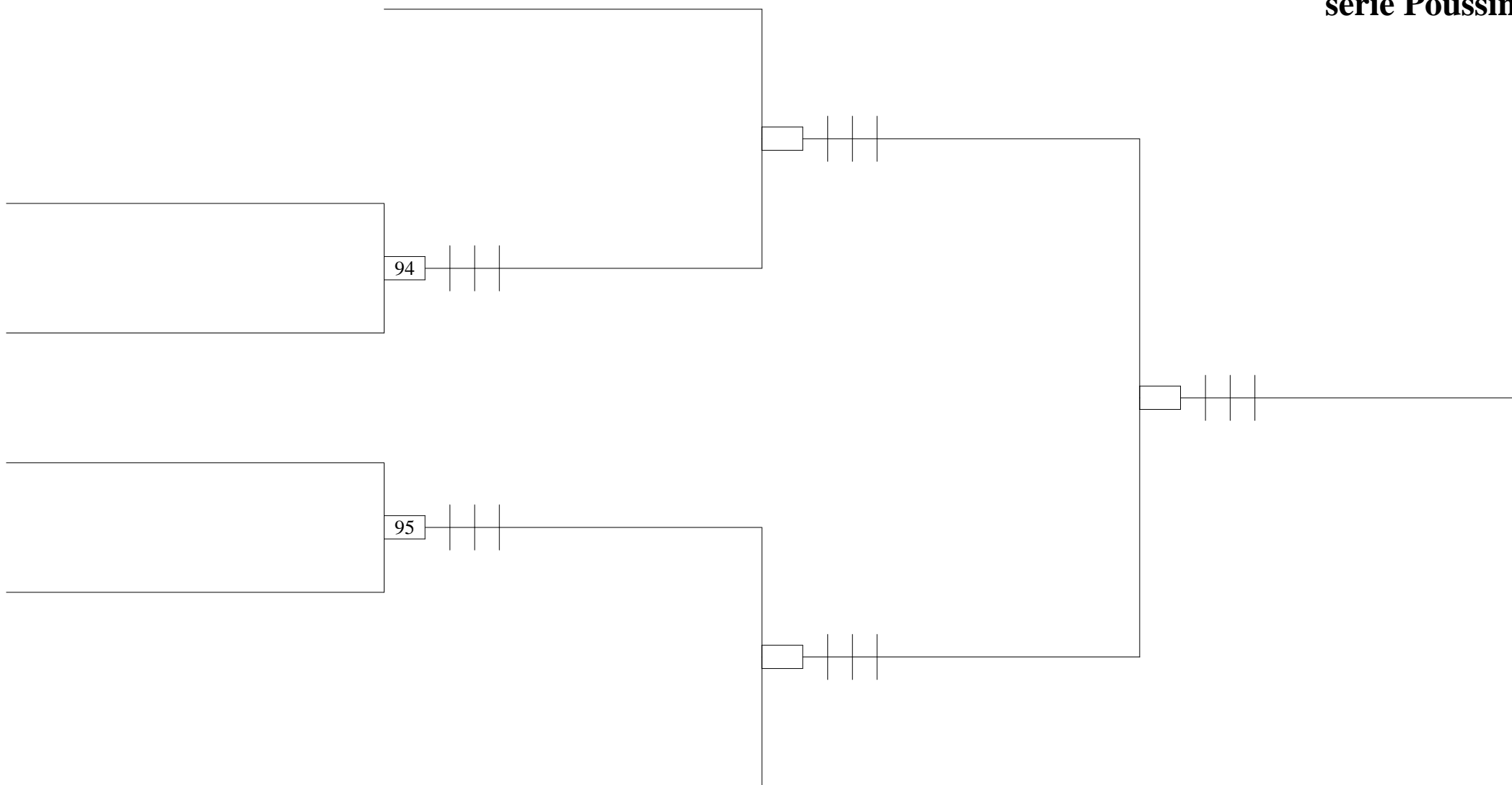

CRJ AURA 2018

double hommes série Poussin

1-PHENGPHACHANH Arthur-NC (CD 38-38)
BOURGIN Timeo-NC (CD 38-38)

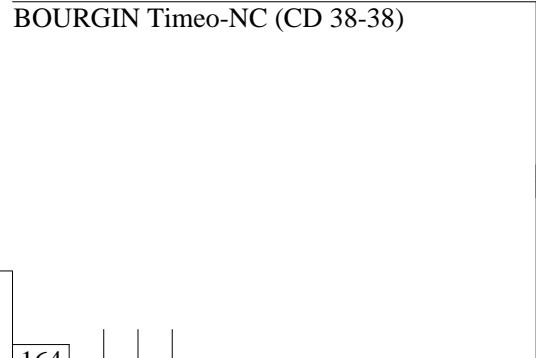

164

BENEZY Enzo-NC (CD 63-63)
ROUSSEL Mathis-NC (CD 63-63)

165

MELIN Kevin-NC (CD 26/07-26/07)
OUDJANI Robin-NC (CD 26/07-26/07)

310

GARDON Terence-NC (CD 38-38)
PIRONNEAU Titouan-NC (CD 38-38)

166

2-SONG Shangxi olivier-NC (BACLY69-69)
LABARRE Antoine-NC (ABC69-69)

327

CRJ AURA 2018

double dames série Poussin

1-GAY Anaïs-NC (BCC74-74)
ISAAC Victoria-NC (EBC69-69)

DUBOIS Jade-NC (BOC73-73)
MANCUSO Elissa-NC (CD 42-42)

RONDAGS Tiphaine-NC (BCM74-74)
BOUVARD Elia-NC (BCM74-74)

TISSIER Celia-NC (CD 26/07-26/07)
MOREL Julie-NC (CD 26/07-26/07)

2-DELETTRE Camille-NC (CD 38-38)
MANARANCHE Elisa-NC (CD 38-38)

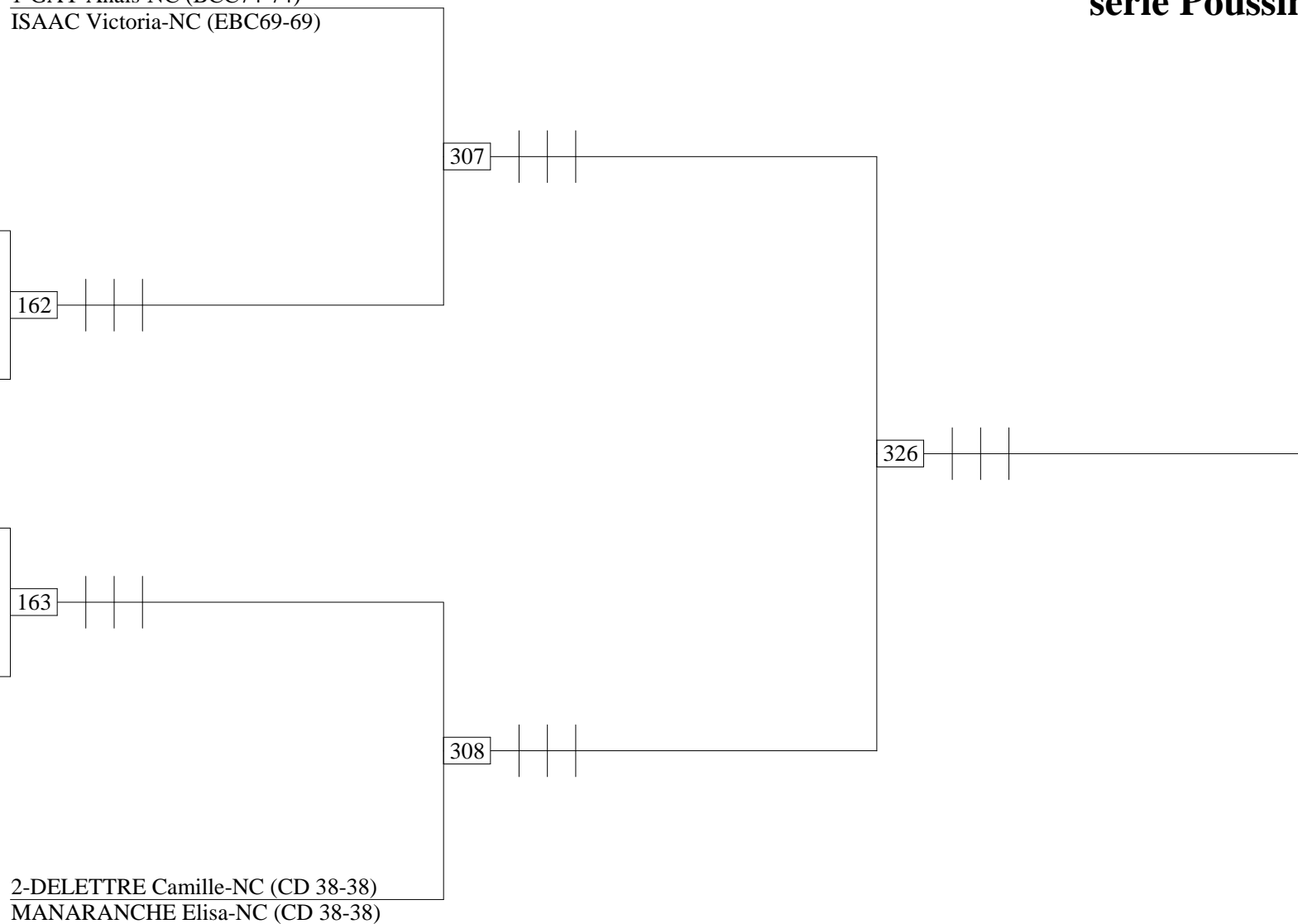

CRJ AURA 2018

Mx Poussin - PouleA

				HERTZOG BIGUET-PETIT-JEAN	Vict.	Sets diff.	Pts diff.	Clt
	FFBaD							
		FFBaD						
HERTZOG Baptiste-NC (SOBAD42- BIGUET-PETIT-JEAN Meline-NC (I				FFBaD				

Mx Poussin - PouleB

				JACQUEMOND MANCUSO	MELIN MOREL	Vict.	Sets diff.	Pts diff.	Clt
	FFBaD								
		FFBaD							
JACQUEMOND Hugo-NC (CD 42-4 MANCUSO Elissa-NC (CD 42-42)				FFBaD					
MELIN Kevin-NC (CD 26/07-26/07) MOREL Julie-NC (CD 26/07-26/07)					FFBaD				

CRJ AURA 2018

simple hommes série Minime TP

1-MAS Korneel-R5 (CBC69-69)

200 $\frac{21|21}{14|15}$ | MAS Korneel

LOUIS GAVET Rémi-R6 (CD 01-01)

LAURENT Adrien-R6 (CD 26/07-26/07)

201 $\frac{18|21|22}{21|11|20}$ | LAURENT Adrien

BARRIONUEVO Mateo-R6 (BACO69-69)

BASTIDE Axel-R6 (BACO69-69)

202 $\frac{19|21|23}{21|12|21}$ | BASTIDE Axel

REPITA Valentin-D7 (CD 42-42)

SAINTOYANT Yanis-R6 (BACO69-69)

203 $\frac{13|21|21}{21|15|23}$ | DEFOURS Thomas

2-DEFOURS Thomas-R6 (BCF42-42)

224 $\frac{21|18|21}{16|21|15}$ | MAS Korneel

245 $\frac{21|21}{19|19}$ | MAS Korneel

225 $\frac{21|21}{18|15}$ | BASTIDE Axel

CRJ AURA 2018

simple dames série Minime TP

1-CAFFIERS Julie-R5 (CD 26/07-26/07)

204 $\frac{21}{16} \frac{21}{14}$ | CAFFIERS Julie

POGNANTE Camille-R6 (CD 38-38)

BERGER Sarah-R5 (CD 38-38)

205 $\frac{21}{18} \frac{21}{23} \frac{21}{18}$ | BERGER Sarah

LABARRE Anaé-R5 (BACLY69-69)

GAUDREAU Clémence-R6 (BCC74-74)

206 $\frac{21}{18} \frac{19}{21} \frac{27}{25}$ | GAUDREAU Clémence

RENAULT-SMAGGHE Vicky-R5 (CD 38-38)

RABEL Coline-R6 (CD 26/07-26/07)

207 $\frac{10}{21} \frac{15}{21}$ | FARGET Maelyne

2-FARGET Maelyne-R5 (BACLY69-69)

226 $\frac{21}{13} \frac{21}{14}$ | CAFFIERS Julie

246 $\frac{21}{14} \frac{19}{21} \frac{21}{18}$ | CAFFIERS Julie

227 $\frac{21}{14} \frac{14}{21} \frac{16}{21}$ | FARGET Maelyne

CRJ AURA 2018

double mixte série Minime TP

1-MAS Korneel-R6 (CBC69-69)

FARGET Maelyne-R5 (BACLY69-69)

259	21	21	MAS Korneel
	12	14	FARGET Maelyne

LOUIS GAVET Rémi-D8 (CD 01-01)

GUILBERT-LY Ai-Linh-D7 (CD 01-01)

275	22	22	MAS Korneel
	20	24	FARGET Maelyne

BARRIONUEVO Mateo-D7 (BACO69-69)

BERGER Sarah-D7 (CD 38-38)

260	21	18	BARRIONUEVO Mateo
	11	21	BERGER Sarah

GARDON Thibault-D8 (CD 38-38)

HOAREAU Malya-D8 (CD 38-38)

291	21	21	MAS Korneel
	9	11	FARGET Maelyne

BASTIDE Axel-D7 (BACO69-69)

LABARRE Anaé-R6 (BACLY69-69)

261	11	21	BASTIDE Axel
	21	15	LABARRE Anaé

LAURENT Adrien-D7 (CD 26/07-26/07)

CAFFIERS Julie-D7 (CD 26/07-26/07)

276	23	21	BASTIDE Axel
	21	18	LABARRE Anaé

SAINTOYANT Yanis-D8 (BACO69-69)

LADRET Jade-D8 (MBC42-42)

262	8	15	LIGER Cedric
	21	21	RENAULT-SMAGGHE Vicky

2-LIGER Cedric-D7 (BCM74-74)

RENAULT-SMAGGHE Vicky-R5 (CD 38-38)

CRJ AURA 2018

simple hommes série Benjamin TP

1-GARDON Thibault-D7 (CD 38-38)

208 $\frac{21}{9} \frac{21}{14}$ | GARDON Thibault

LAURENT Tom-D8 (CD 26/07-26/07)

228 $\frac{21}{14} \frac{22}{20}$ | GARDON Thibault

DELETTRE Malo-D7 (CD 38-38)

209 $\frac{21}{18} \frac{11}{21} \frac{20}{22}$ | RIOU Théotime

RIOU Théotime-D7 (BACO69-69)

247 $\frac{18}{21} \frac{21}{14} \frac{18}{21}$ | CATTALANO Axel

SCIASCIA Noam-D7 (BPV38-38)

210 $\frac{24}{22} \frac{10}{21} \frac{16}{21}$ | BISSAY Ethan

BISSAY Ethan-D7 (BACLY69-69)

229 $\frac{21}{19} \frac{10}{21} \frac{13}{21}$ | CATTALANO Axel

POLODNA Aubin-Tim-D7 (PMBB74-74)

211 $\frac{21}{18} \frac{6}{21} \frac{18}{21}$ | CATTALANO Axel

2-CATTALANO Axel-D7 (CD 38-38)

CRJ AURA 2018

simple dames série Benjamin TP

1-RATTIN Line-D7 (CBC69-69)

212 $\frac{21}{13} \frac{21}{10}$ | RATTIN Line

VANHULLE Charline-D7 (CD 63-63)

230 $\frac{21}{19} \frac{21}{17}$ | RATTIN Line

RENAULT-SMAGGHE Clarysse-D7 (CD 38-38)

213 $\frac{21}{13} \frac{21}{16}$ | RENAULT-SMAGGHE Clarysse

RAJAUD Zoé-D7 (CD 42-42)

248 $\frac{22}{20} \frac{18}{21} \frac{21}{17}$ | RATTIN Line

POULBOT Louise-D7 (CD 63-63)

214 $\frac{15}{21} \frac{22}{20} \frac{9}{21}$ | HOUL Nina

HOUL Nina-D7 (CD 42-42)

231 $\frac{22}{20} \frac{19}{21} \frac{21}{16}$ | HOUL Nina

BASTIDE Estel-D7 (BACO69-69)

215 $\frac{17}{21} \frac{20}{22}$ | LENOIR Laureline

2-LENOIR Laureline-D7 (ALE38-38)

CRJ AURA 2018

double mixte série Benjamin TP

1-SCIASCIA Noam-D8 (BPV38-38)

RATTIN Line-D8 (CBC69-69)

263

21	24
16	22

 | SCIASCIA Noam
RATTIN Line

RIOU Théotime-D9 (BACO69-69)

POULBOT Louise-D9 (CD 63-63)

277

17	21
21	23

 | FRANCON Anton
BASTIDE Estel

CATTALANO Axel-D9 (CD 38-38)

RENAULT-SMAGGHE Clarysse-D9 (CD 38-

264

15	20
21	22

 | FRANCON Anton
BASTIDE Estel

FRANCON Anton-P10 (CBC69-69)

BASTIDE Estel-D9 (BACO69-69)

292

9	14
21	21

 | POLODNA Aubin-Tim
GAUDREAU Clémence

GLEMBA Pierre-D9 (CD 26/07-26/07)

SPANO Charlotte-D9 (CD 26/07-26/07)

265

19	21	23
21	16	25

 | DELETTRE Malo
ANDREOLETY Melissa

DELETTRE Malo-D9 (CD 38-38)

ANDREOLETY Melissa-P10 (CD 38-38)

278

12	15
21	21

 | POLODNA Aubin-Tim
GAUDREAU Clémence

BALMELLE Carlo-P10 (CD 26/07-26/07)

LOMBARD Léna-P10 (CD 26/07-26/07)

266

7	7
21	21

 | POLODNA Aubin-Tim
GAUDREAU Clémence

2-POLODNA Aubin-Tim-D9 (PMBB74-74)

GAUDREAU Clémence-D8 (BCC74-74)

CRJ AURA 2018

simple hommes série Poussin TP

1-BOURGIN Timeo-NC (CD 38-38)

216 $\frac{21}{10} | \frac{21}{11} |$ | BOURGIN Timeo

TRACOULAT Léo-NC (BCM74-74)

PIRONNEAU Titouan-NC (CD 38-38)

217 $\frac{15}{21} | \frac{26}{24} | \frac{23}{21} |$ | PIRONNEAU Titouan

LABARRE Antoine-NC (ABC69-69)

232 $\frac{21}{7} | \frac{21}{4} |$ | BOURGIN Timeo

OUDJANI Robin-NC (CD 26/07-26/07)

218 $\frac{17}{21} | \frac{14}{21} |$ | SONG Shangxi olivier

SONG Shangxi olivier-NC (BACLY69-69)

233 $\frac{21}{16} | \frac{21}{15} |$ | SONG Shangxi olivier

MONARD Timothy-NC (CD 01-01)

219 $\frac{18}{21} | \frac{16}{21} |$ | PHENGPHACHANH Arthur

2-PHENGPHACHANH Arthur-NC (CD 38-38)

249 $\frac{21}{13} | \frac{21}{9} |$ | BOURGIN Timeo

CRJ AURA 2018

simple dames série Poussin TP

1-ISAAC Victoria-NC (EBC69-69)

220 $\frac{21}{3} | \frac{21}{10} |$ ISAAC Victoria

BIGUET-PETIT-JEAN Meline-NC (B2A74-74)

234 $\frac{21}{18} | \frac{21}{9} |$ ISAAC Victoria

DELETTRE Camille-NC (CD 38-38)

221 $\frac{17}{21} | \frac{20}{22} |$ MANARANCHE Elisa

MANARANCHE Elisa-NC (CD 38-38)

250 $\frac{21}{7} | \frac{22}{20} |$ ISAAC Victoria

DUBOIS Jade-NC (BOC73-73)

222 $\frac{24}{22} | \frac{21}{17} |$ DUBOIS Jade

MAS Marie-NC (CBC69-69)

235 $\frac{21}{9} | \frac{21}{12} |$ DUBOIS Jade

BOUVARD Elia-NC (BCM74-74)

223 $\frac{14}{21} | \frac{14}{21} |$ GAY Anaïs

2-GAY Anaïs-NC (BCC74-74)

CRJ AURA 2018

double mixte série Poussin TP

1-PHENGPACHANH Arthur-NC (CD 38-38)

GAY Anaïs-NC (BCC74-74)

267 21|12|24|BOURGIN Timeo
16|21|26|POGNANTE Emma

BOURGIN Timeo-NC (CD 38-38)

POGNANTE Emma-NC (GAB38-38)

279 21|21|BOURGIN Timeo
13|16|POGNANTE Emma

PIRONNEAU Titouan-NC (CD 38-38)

MANARANCHE Elisa-NC (CD 38-38)

268 21|16|15|TRACOULAT Léo
19|21|21|BOUVARD Elia

TRACOULAT Léo-NC (BCM74-74)

BOUVARD Elia-NC (BCM74-74)

293 12|21|21|BOURGIN Timeo
21|16|19|POGNANTE Emma

GARDON Terence-NC (CD 38-38)

DELETTRE Camille-NC (CD 38-38)

269 10|16|SONG Shangxi olivier
21|21|MAS Marie

SONG Shangxi olivier-NC (BACLY69-69)

MAS Marie-NC (CBC69-69)

280 12|19|LABARRE Antoine
21|21|ISAAC Victoria

OUDJANI Robin-NC (CD 26/07-26/07)

RONDAGS Tiphaine-NC (BCM74-74)

270 14|12|LABARRE Antoine
21|21|ISAAC Victoria

2-LABARRE Antoine-NC (ABC69-69)

ISAAC Victoria-NC (EBC69-69)

CRJ AURA 2018

simple hommes

série Cadet

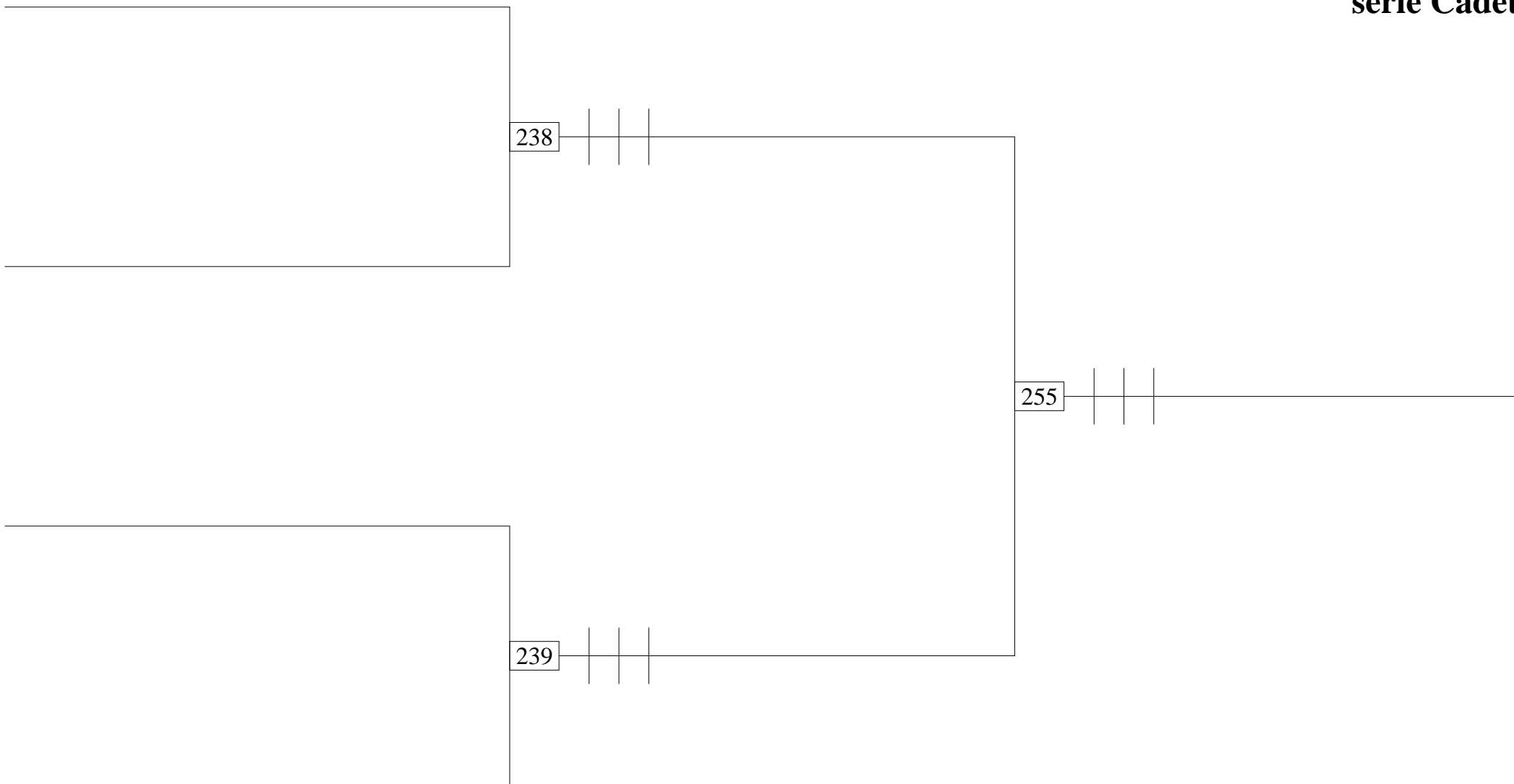

CRJ AURA 2018

simple dames

série Cadet

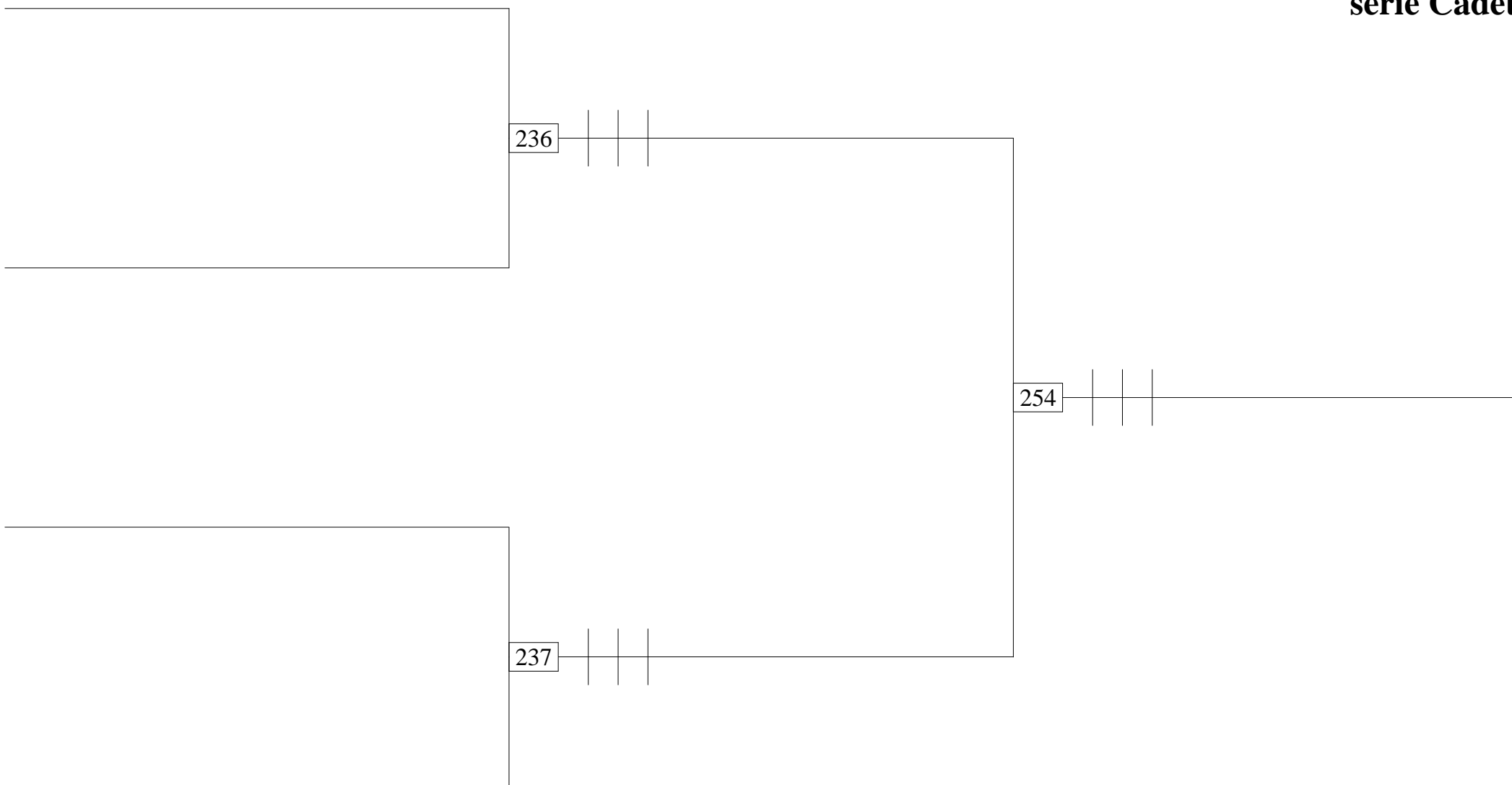

CRJ AURA 2018

double hommes
série Cadet

1-BULIDON Maxence-N3 (CD 63-63)
PHENGPACHANH Maxime-R4 (CD 38-38)

167

VIVIANT Clarence-R5 (ABC74-74)
BARTHUEL Adrien-R5 (CD 63-63)

313

CAILLE Guillaume-R5 (ABC74-74)
CRETAUD Thomas-R4 (ABC74-74)

168

BERTHOMME Romain-R4 (CBC69-69)
LACROIX Quentin-R4 (BACLY69-69)

329

DUMONT-GIRARD Nicolas-R5 (CD 38-38)
GEREAU Maxence-R5 (BCIA38-38)

169

REMAUD Julien-R5 (CD 26/07-26/07)
FRESSE Guillaume-R5 (CD 26/07-26/07)

314

VOINIER Hugo-R4 (SCPGBAD42-42)
CORRIETTE Maxence-R5 (BACLY69-69)

170

2-MAS Korneel-R5 (CBC69-69)
LOVANG Kimi-N3 (BACO69-69)

CRJ AURA 2018

double dames série Cadet

1-MAMMERI Tanina-N2 (BACO69-69)
MANARANCHE Julie-N2 (CD 38-38)

CAFFIERS Julie-R6 (CD 26/07-26/07)
POULBOT Noémie-N3 (CD 63-63)

HOAREAU Li-Lou-N3 (CD 38-38)
SOCQUET-CLERC Mathilde-N3 (PMBB74-74)

DEPOORTER Charlène-R4 (CBC69-69)
BRON Salomé-R4 (TBC74-74)

JANIN Emma-N3 (ACB38-38)
PRIMET Orlane-N3 (MBC42-42)

2-MAKINADJIAN Lisa-N2 (CD 26/07-26/07)
BASTIDE Juliette-N2 (CD 63-63)

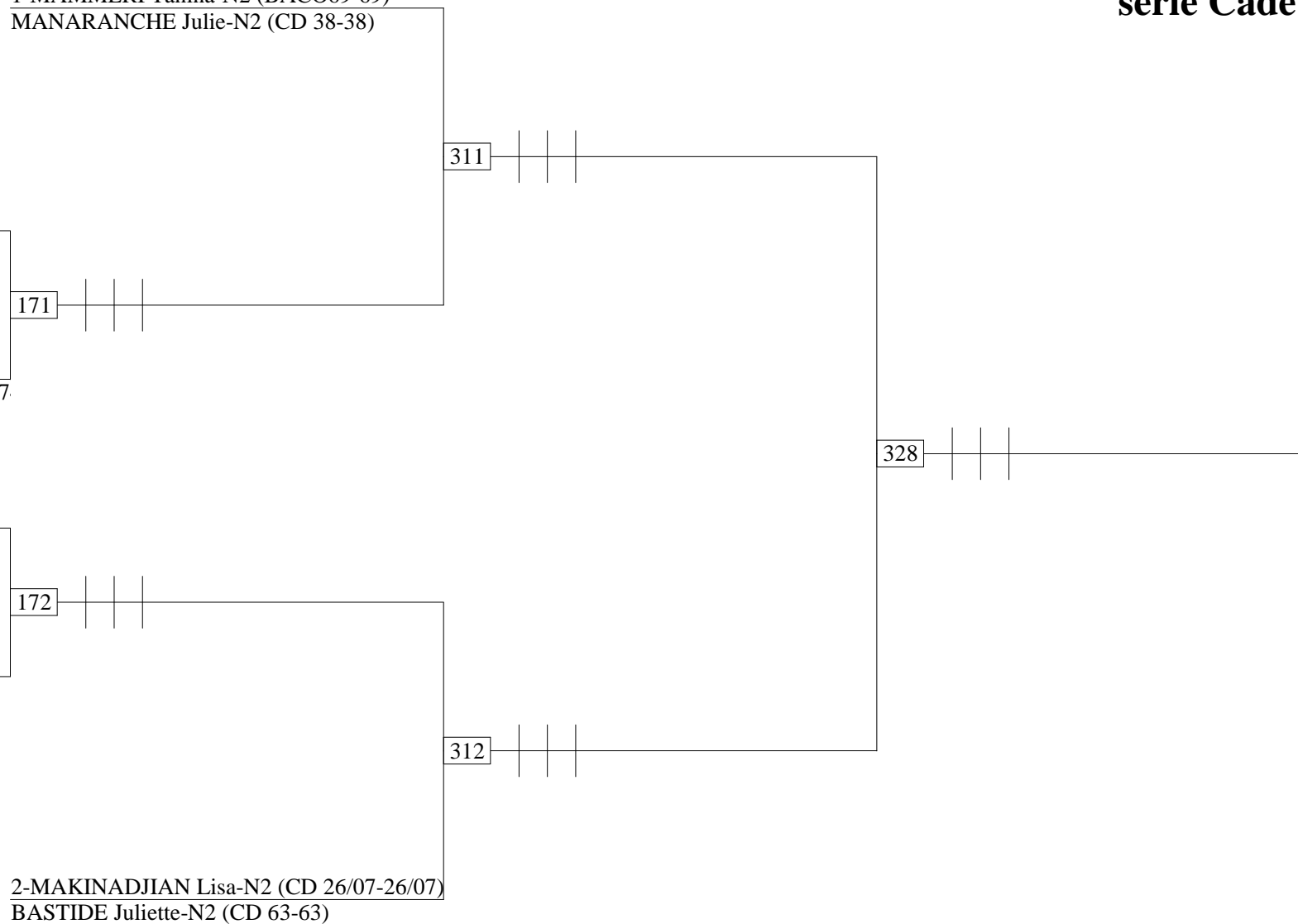

CRJ AURA 2018

double mixte
série Cadet

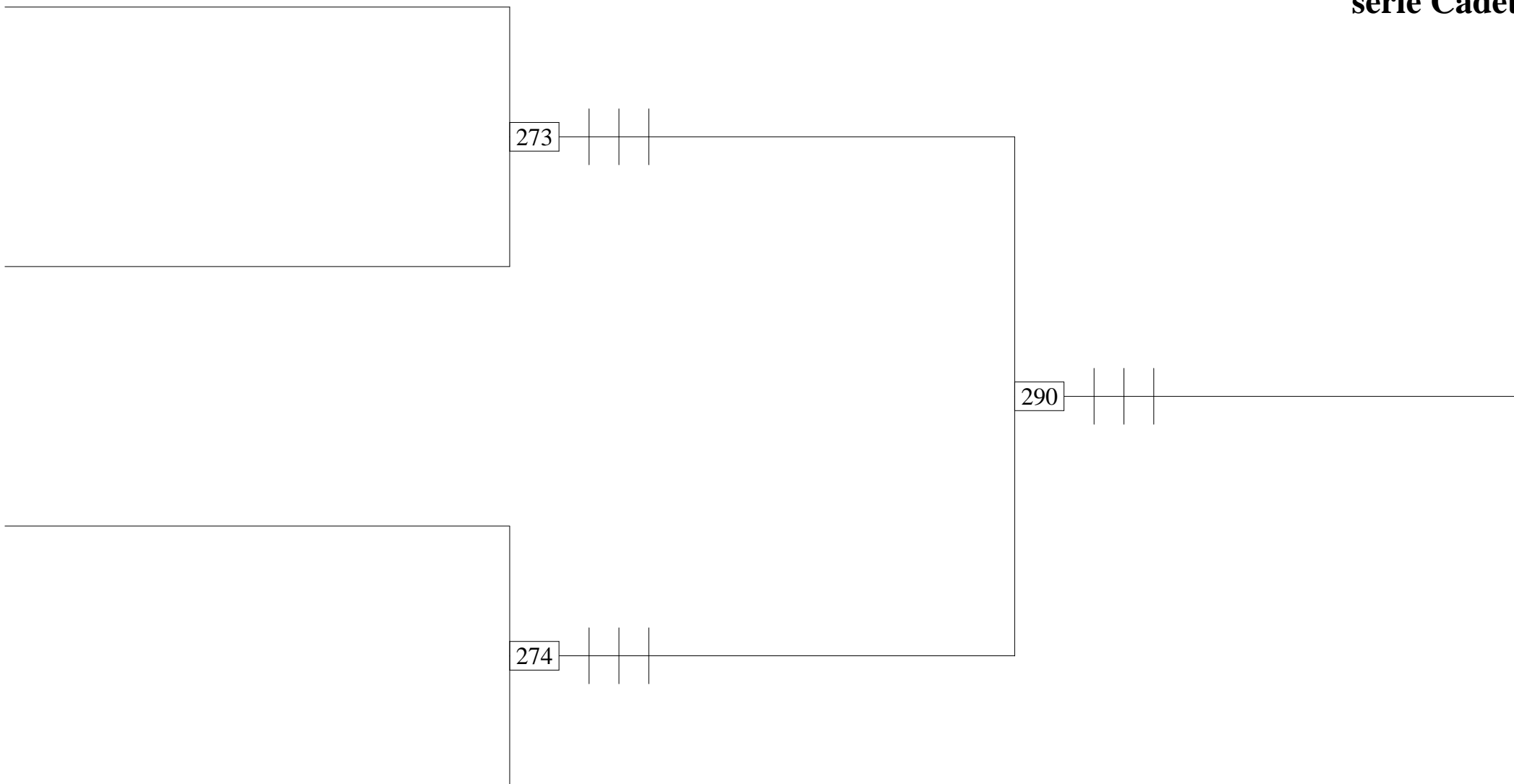

CRJ AURA 2018

double hommes
série Minime

1-LOUIS GAVET Rémi-R6 (CD 01-01)

LIGER Cedric-R6 (BCM74-74)

176

THIRIET Alex-D9 (GAB38-38)

CUENOT Zacharie-D9 (GAB38-38)

301

SAINTOYANT Yanis-D7 (BACO69-69)

BEYROUTI Wilfrid-D7 (BACO69-69)

177

REPITA Valentin-D8 (CD 42-42)

DIGONNET Vadim-D8 (SJBC42-42)

318

BONNAMOUR Arthur-D8 (CD 63-63)

ROCHE Killian-D8 (CD 63-63)

178

LAURENT Adrien-D7 (CD 26/07-26/07)

GACHET Titouan-D7 (ALE38-38)

302

REYNAUD Yohann-P10 (ACB38-38)

JANIN Thomas-P10 (ACB38-38)

179

2-BASTIDE Axel-R6 (BACO69-69)

BARRIONUEVO Mateo-R6 (BACO69-69)

CRJ AURA 2018

double hommes série Benjamin

1-CATTALANO Axel-D8 (CD 38-38)

GARDON Thibault-D8 (CD 38-38)

158

RANNOU Hugo-D9 (BACO69-69)

RIOU Théotime-D9 (BACO69-69)

305

LUCCHESI-PALLI Lucas-P10 (CD 26/07-26/07)

BALMELLE Carlo-D9 (CD 26/07-26/07)

159

LONCHAMPT Edwin-P10 (CD 63-63)

RAMANANA-RAHARY Tahina-P10 (CD 63-63)

320

SCIASCIA Noam-D9 (BPV38-38)

FRANCON Anton-D9 (CBC69-69)

160

LAURENT Tom-D9 (CD 26/07-26/07)

GLEMBA Pierre-D9 (CD 26/07-26/07)

306

FREMONT Tom-D9 (ALE38-38)

DELETTRE Malo-D9 (CD 38-38)

161

2-BISSAY Ethan-D8 (BACLY69-69)

POLODNA Aubin-Tim-D8 (PMBB74-74)

CRJ AURA 2018

double dames série Minime

1-FARGET Maelyne-R4 (BACLY69-69)
RENAULT-SMAGGHE Vicky-R4 (CD 38-38)

GAUDREAU Clémence-D7 (BCC74-74)
POGNANTE Camille-R6 (CD 38-38)

GUERRIN Emilie-R6 (BCC69-69)
BLACHE Maeva-D8 (BACLY69-69)

LADRET Jade-R6 (MBC42-42)
HOAREAU Malya-D7 (CD 38-38)

RABEL Coline-R5 (CD 26/07-26/07)
VEYRARD Lisa-D7 (BM42-42)

NGUYEN Mai-Phuong-P10 (ACB38-38)
NEMOZ Louane-D9 (BCIA38-38)

2-LABARRE Anaé-R6 (BACLY69-69)
BERGER Sarah-R5 (CD 38-38)

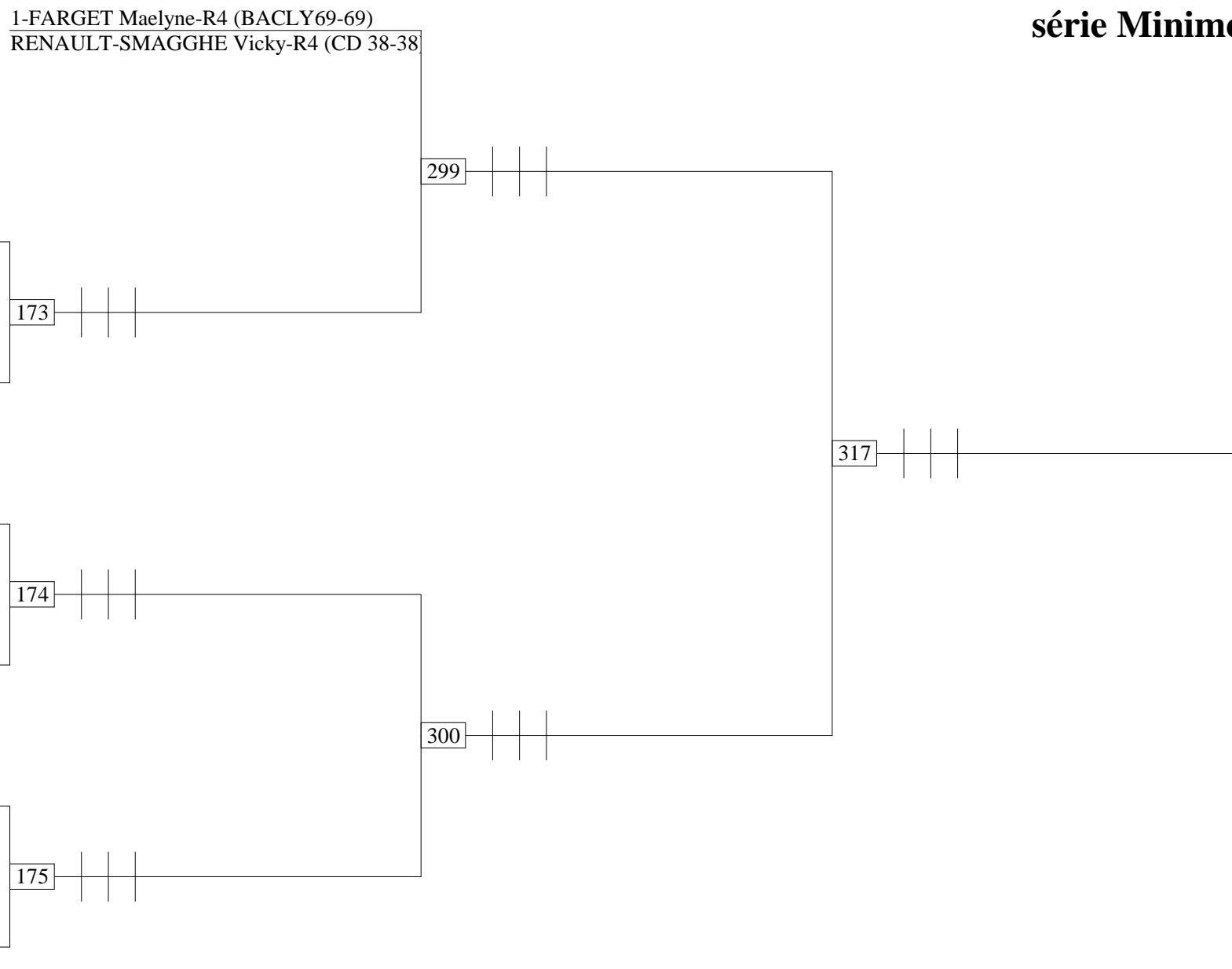

CRJ AURA 2018

double dames série Benjamin

1-RENAULT-SMAGGHE Clarysse-D9 (CD 3-3)
BASTIDE Estel-D9 (BACO69-69)

154

LACROIX Margaux-P12 (BOC73-73)
DAUVERCHAIN Lucie-P10 (BOC73-73)

303

LENOIR Laureline-D9 (ALE38-38)
SPANO Charlotte-D9 (CD 26/07-26/07)

155

VANHULLE Charline-D9 (CD 63-63)
ANDREOLETY Melissa-D9 (CD 38-38)

319

AYMARD Noémie-P10 (CD 26/07-26/07)
LOMBARD Léna-P10 (CD 26/07-26/07)

156

RAJAUD Zoé-D9 (CD 42-42)
HOUL Nina-D9 (CD 42-42)

304

CUENOT Ileya-P10 (ALE38-38)
DUBUS Eléonore-P12 (LDCB38-38)

157

2-POULBOT Louise-D9 (CD 63-63)
RATTIN Line-D9 (CBC69-69)

CRJ AURA 2018

double dames série Poussin

1-GAY Anaïs-NC (BCC74-74)
ISAAC Victoria-NC (EBC69-69)

DUBOIS Jade-NC (BOC73-73)
MANCUSO Elissa-NC (CD 42-42)

RONDAGS Tiphaine-NC (BCM74-74)
BOUVARD Elia-NC (BCM74-74)

TISSIER Celia-NC (CD 26/07-26/07)
MOREL Julie-NC (CD 26/07-26/07)

2-DELETTRE Camille-NC (CD 38-38)
MANARANCHE Elisa-NC (CD 38-38)

